

ZOOM Nitro® QUICK REFERENCE INSTALLATION GUIDE

INSTALLATION:

Tools, Equipment, & Material Required:

- General hand tools, screwdrivers, etc.
- Tape Measure, pencil/marker
- Drill with drill bit set
- Fish sticks/tape for routing cables (if necessary)
- Cable ties for bundling cables and strain relief
- Belden 8723 audio cable or equivalent
- Protective equipment such as safety glasses.



Fig. 1.1

- 1 Check the packing list! Verify you have received everything listed.
- 2 Survey the premises with store manager to determine the optimal mounting location for the ZOOM Nitro. Take into consideration:
 - User accessibility
 - Appropriate space for mounting all system components
 - Proximity to a power outlet
 - Cable lengths required between connections
 - Clearance from obstructions like electrical and plumbing obstructions when drilling
 - Mount the system high enough on a wall to be out of the way but still visible/accessible.
- 3 Remove (if attached) and discard the monitor base stand (see Fig 1.2).

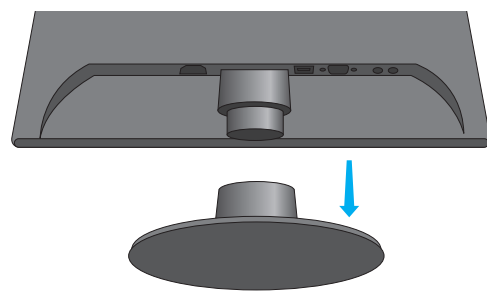

Fig. 1.2

- 4 Mount the monitor bracket to the wall. To do this, find an appropriate location (preferably along a stud if wall construction is a wood stud frame).
 - Hold the wallplate level against the wall, and mark the wall through the two mounting holes.
 - Drill holes at the marked locations.
 - Mount the bracket to the wall using the necessary hardware (screws and wall anchors or toggle bolts if necessary); see Fig. 1.3.

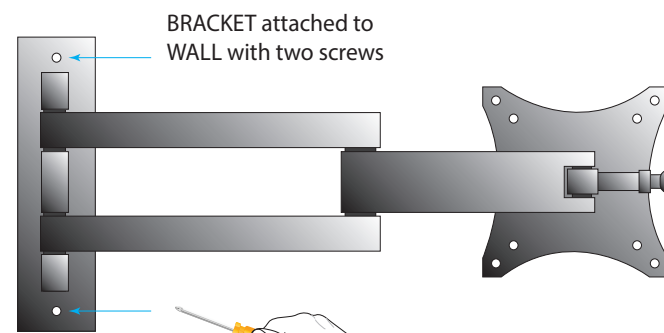

Fig. 1.3

- 5 Attach the monitor to the faceplate with the provided hardware (see Fig. 1.4).

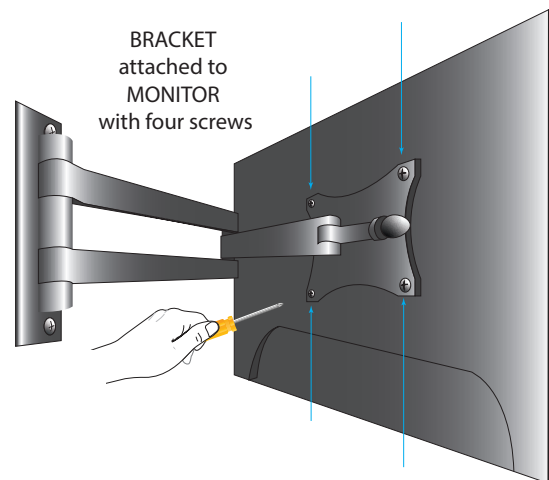

Fig. 1.4

- 6 Attach the CU to the CU wallplate using the provided hardware (see Fig. 1.5).

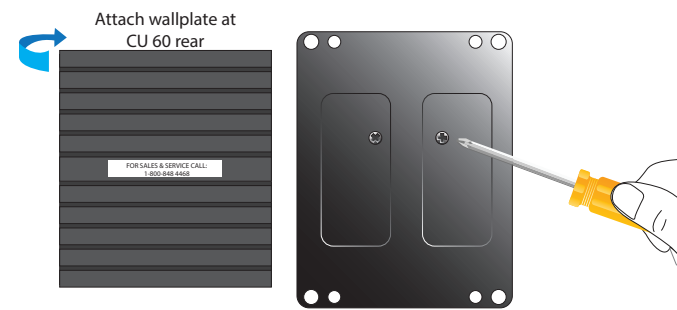

Fig. 1.5

- 7 Mount the CU on the wall.
 - Hold the plated CU against the wall, and mark the wall through the four outside mounting holes.
 - Drill holes at the marked locations.
 - Mount the plated CU to the wall using the necessary hardware (screws and wall anchors if necessary); see Fig. 1.6

Note: The HME Sales and Service sticker should be right side up.

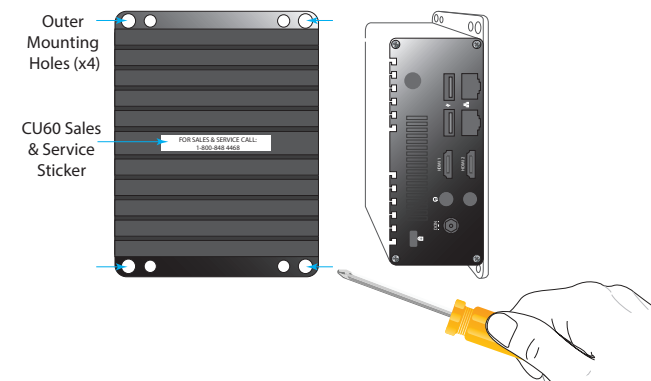

Fig. 1.6

- 8 Connect the cables (reference Fig. 1.7 for each step):
 1. Connect the network cable to the network port (verify it is also connected at the network router end).
 2. Connect a mouse (and keyboard if desired) to the USB port (see all connections in the following diagram).
 3. Connect the HDMI cable for the primary monitor to the port labeled HDMI 1.
 4. Connect the power adapter.

Note: HDMI 2 is for the Drive-Thru Leaderboard display (if desired). Remove port cap to access.

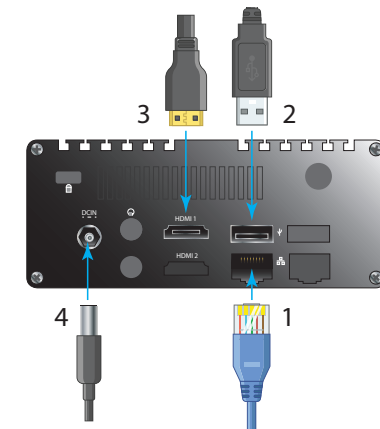

Fig. 1.7

- 9 Connect the power cable and the HDMI cable to the monitor (see Fig. 1.8). Connect the other end of the power cable to an electrical outlet.

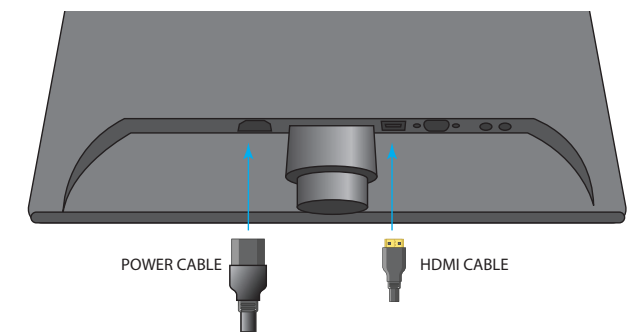

Fig. 1.8

10 Mount the TSP60 using the three mounting keyholes at the rear of the unit. The two lower keyholes can be accessed by opening the lower front cover of the housing. The latch is magnetic, use the finger tabs on both sides and pull back from the housing to open (see Fig. 2.1).

- Use the TSP Template image on the last page of this guide to punch through and mark all three mounting keyholes on the wall (the top hole cannot be accessed through the TSP housing).
- Drill three holes at the marked locations.
- Install the provided hardware (screws and wall anchors if necessary) but do not tighten the screws. Leave a gap (~ 1/8th inch (3.2 mm)) between the screw heads and wall.

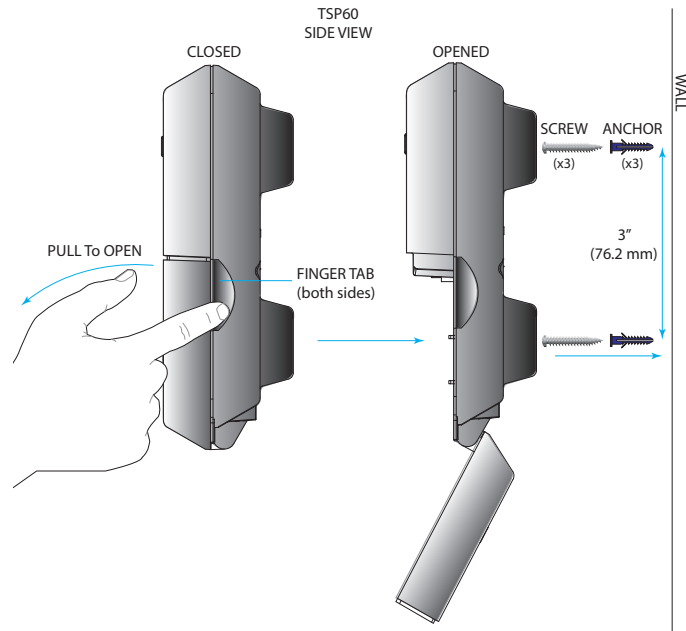

Fig. 2.1

- Align the keyholes to the screw heads.
- Mount the TSP60 over all three screw heads until flush against the wall, then slide down onto the screw shanks to secure it in place.

11 Route and terminate component cables to the TSP60 through the opening on the rear housing. Refer to the TSP Wiring Connections and Fig. 3.1 on page 3 while following these next few steps.

12 Connecting Loop Detectors:

After the Base Station has been connected to the TSP, connect the first loop detector cable to the LOOP1 connector (J4) of the TSP using Red

and Black wires. These may be connected in any order (see Fig. 2.4). Any additional loops after the menu point, such as a pickup window or a pull-forward spot, can be connected to LOOP2, 3, and 4 connectors (J5, J6, and J7), respectively. **Note:** Activation is required to use LOOP2 - 4.

13 When connecting a base station, choose one of the following steps: A, if connecting a NEXEO|H-DX™ Base Station to the TSP, or B, if connecting an EOS|HD® Base Station to the TSP. Also, refer to Fig. 3.1 wiring connections on page 3.

A For NEXEO®: Connect the Green and White wires from J800-1&2 on the base station to the Greet1 terminals J1-1&2 on the TSP (see Fig. 2.2). With polarized terminals, always connect +ve to +ve and -ve to -ve. Connect the Shield wire to ground (pin 5 on J800 & J1). Connect the remaining Red wire from J800-7 to J2-1 and Black wire from J800-6 to J2-2 (or any of the available detector inputs). For stores with another menu (e.g., a Y-Lane), repeat this step using J801 on the base station to Greet2 and another detector input on the TSP.

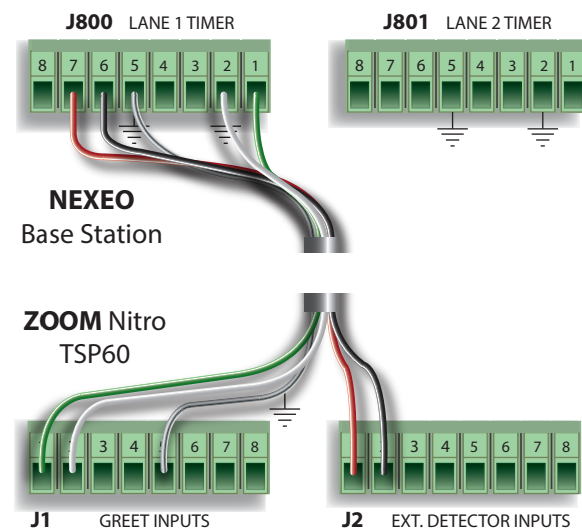

Fig. 2.2

B For EOS: Connect the Green and White wires from J6-7&8 on the base station to the Greet1 terminals J1-1&2 on the TSP (see Fig. 2.3). With polarized terminals, always connect +ve to +ve and -ve to -ve. Connect the

Shield wire to ground on both ends. Connect the remaining Red wire from J1-4 to J2-1 and Black wire from J1-3 to J2-2 (or any of the available detector inputs). For stores with another menu (e.g., a Y-Lane), repeat this step (for Greet 2 and Menu 2) and connect to Greet2 and another detector input on the TSP.

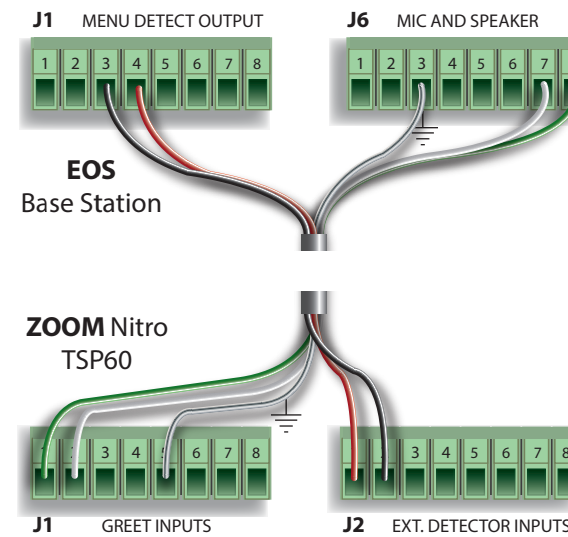

Fig. 2.3

14 Connecting the USB cable:

Connect the USB type B end to the TSP60. Connect the other end to the Black (bottom) USB port on the front panel of the CU60. The TSP60 turns on automatically when the CU60 is powered on (see Fig. 2.4).

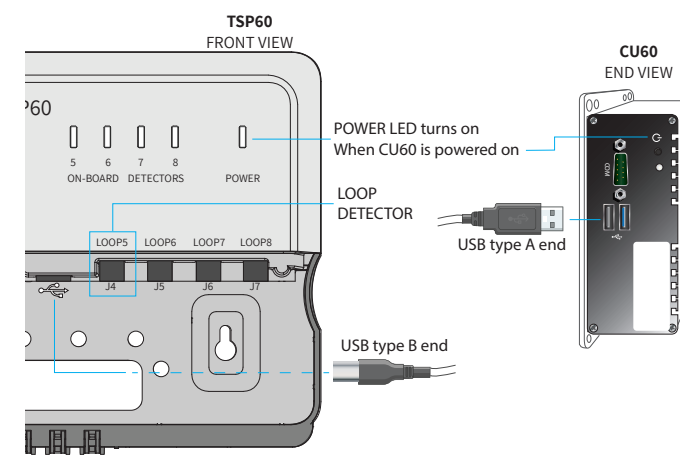

Fig. 2.4

15 Use cable ties and the strain relief holes on the TSP60 rear housing to bundle and strain relief the cables exiting the unit at the rear.

16 Turn on the CU60 (if it was not turned on in step 14) and turn on the monitor using the power button.

17 The ZOOM Nitro screen:

- When you first boot up the system, the Installation Wizard screen appears (see Fig. 2.5).
- The Installation Wizard walks you through several screens. Fill in the required information to progress to the next screen. For example, on the second screen, you must scroll through and read EULA page and click on the Agree button to advance to the next screen. When you reach the Network Settings screen, enable "DHCP" to auto-populate the fields. Finally, a Congratulations prompt completes the Installation Wizard; click Done to exit. The Dashboard now appears.
- Click the menu icon in the Dashboard's upper left corner, choose the SECURITY option, and log in as the Installer.
- Use the CAR DETECTION SETTINGS option to configure system to the store's layout. Use the STORE and DASHBOARD SETTINGS options to customize the system further based on the customer's preference.

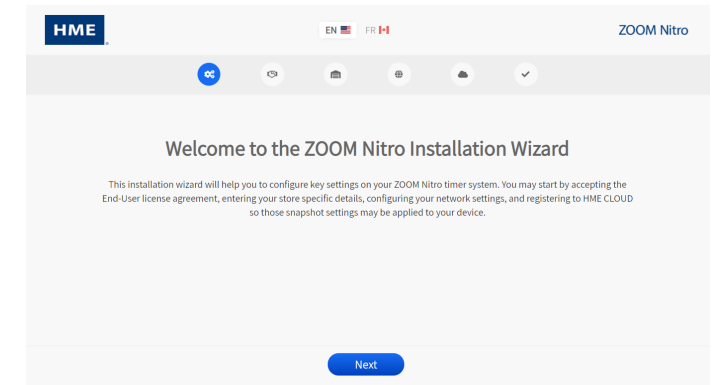

Fig. 2.5

18 Your system is now ready for use.

- Refer to the ZOOM Nitro User's Guide for details on how to use the system.
- If there are any installation issues, call HME Technical Support at 1.800.848.4468.

TSP WIRING CONNECTIONS

J1 Greet Inputs		
Pin #	Label	Description/wire color
1	GREET1+	From NEXEO Base Station: J800-1 or EOS Base Station: J6-8, +ve Outside Mic/Speaker wire. (Green wire)
2	GREET1-	From NEXEO Base Station: J800-2 or EOS Base Station: J6-7, -ve Outside Mic/Speaker wire. (White wire)
3	GREET2+	
4	GREET2-	
5	GND	Ground/Shield wire from either Base Station
6	/ALT_GREET1	
7	/ALT_GREET2	
8	GND	

J1 supports two greet signal inputs from the Base Station. Standard greet signals received from the audio lines (speakers) are terminated at GREET1 and GREET2 inputs. The ALT GREET 1 & 2 inputs are for digital inputs from other sources, such as using a headset button. Two greet signals is the maximum supported at the same time. Both can be from the same source or can be a combination of two sources such as GREET1 and ALT GREET2.

J2 External Detector Inputs		
Pin #	Label	Description/wire color
1	EXT_IN1/RLY_NO	From NEXEO Base Station: J800-7 or EOS Base Station: J1-4, +ve Menu Det. wire. (Red wire)
2	GND/RLY_COM	From NEXEO Base Station: J800-6 or EOS Base Station: J1-3, GND Menu Det. wire. (Black wire)
3	EXT_IN2/RLY_NO	
4	GND/RLY_COM	
5	EXT_IN3/RLY_NO	
6	GND/RLY_COM	
7	EXT_IN4/RLY_NO	
8	GND/RLY_COM	

J2 supports four external detector inputs. These include both relay closure and logic-level signal inputs in support of non-HME, wireless or generic detectors, including positive polarity signal compatibility.

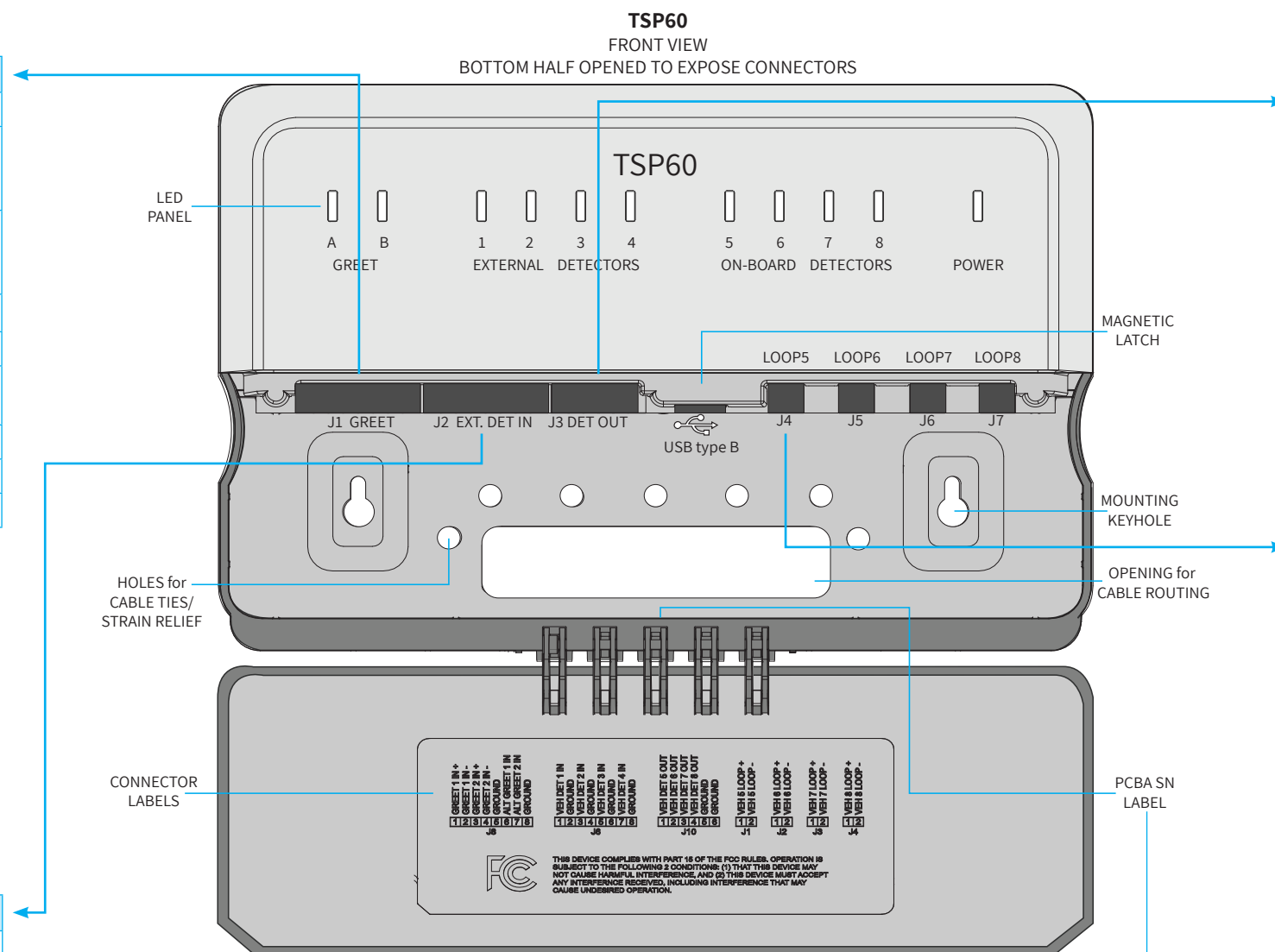

Fig. 3.1

LED state table	
LED	Status/Description
POWER	Solid Blue and always on if the CU is on and connected to the TSP
GREET	Solid Blue, only on when the host is speaking
EXTERNAL DETECTORS	Solid Blue, only on when a detector is connected, and a vehicle is detected at the corresponding detection point
ON-BOARD DETECTORS	Solid Blue, only on when a detector is connected, and a vehicle is detected at the corresponding detection point

PCBA SN Label: This serial number identifies the TSP60 if more than one is used. It can be found under TSP SETTINGS>TSP60 on the ZOOM Nitro display (see Fig. 3.2).

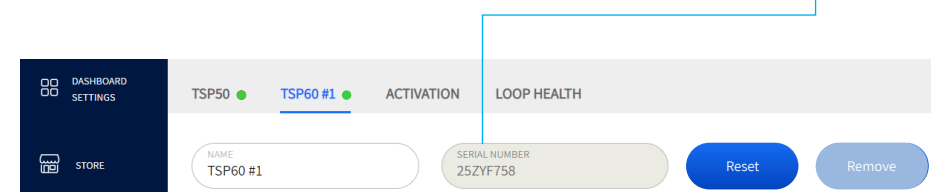

Fig. 3.2

J3 Vehicle Detection Output		
Pin #	Label	Description/wire color
1	VEH_DET_OUT1	Output signal from LOOP5 (at J4)
2	VEH_DET_OUT2	Output signal from LOOP6 (at J5)
3	VEH_DET_OUT3	Output signal from LOOP7 (at J6)
4	VEH_DET_OUT4	Output signal from LOOP8 (at J7)
5	GND	
6	GND	

J3 is for Vehicle Detection outputs to the Base Station to support menu detection in the absence of an external VDB. These outputs are from the four Onboard detectors.

J4, J5, J6, J7 Onboard Detector Inputs		
Pin #	Label	Description/wire color
J4-1	Loop 5 +ve	Menu point/first detector loop in Lane
J4-2	Loop 5 -ve	
J5-1	Loop 6 +ve	Additional loop after first detection point
J5-2	Loop 6 -ve	
J6-1	Loop 7 +ve	Additional loop after first detection point
J6-2	Loop 7 -ve	
J7-1	Loop 8 +ve	Additional loop after first detection point
J7-2	Loop 8 -ve	

J4 is the default available onboard VDB for a direct connection. Connect loop/wireless detector input here.

In addition to accepting a direct detector connection, these inputs (J4 - J7) can also be configured to support both relay closure and logic-level signal inputs.

J5 - J7 requires activation to use (call HME at the phone number at the end of this guide for details).

Installer Note

For ZOOM Nitro versions 6.2 and above, a new installer password is required. This password is available via the Installer Portal here: <https://technicians.hme.com/Admin/Login?invalid>

For ZOOM Nitro versions 6.0 and below, the old password can still be used.

TSP60
TEMPLATE FOR MOUNTING HARDWARE
 This way up

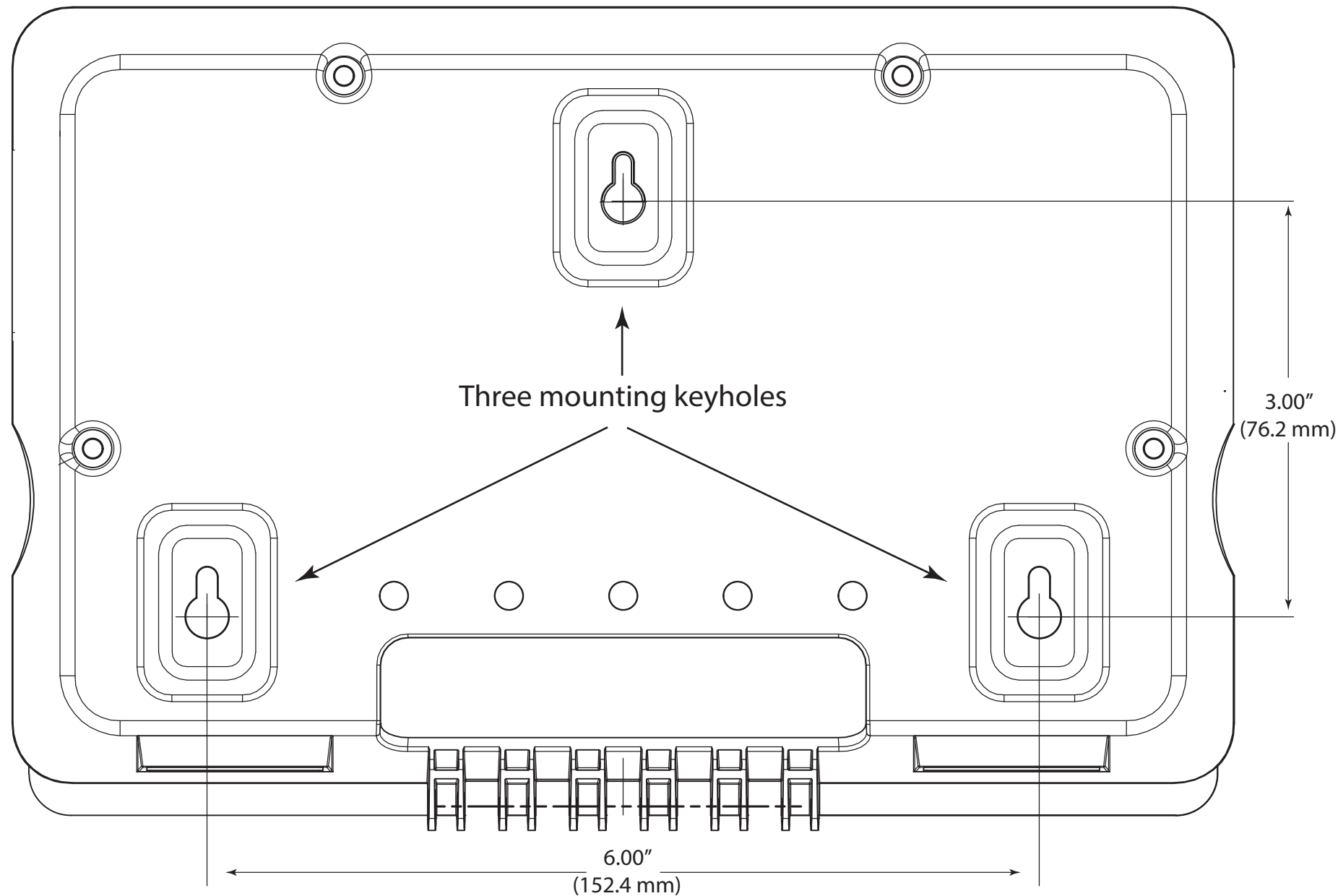

Radio and Television Interference

FCC Regulation

This device complies with Part 15 of the FCC rules. Operation is subject to the following two conditions: (1) This device may not cause harmful interference, and (2) This device must accept any interference received, including interference that may cause undesired operation. This equipment has been tested and found to comply with the limits for a Class A digital device, pursuant to Part 15 of the FCC rules. These limits are designed to provide reasonable protection against harmful interference when the equipment is operated in a commercial environment. This equipment generates, uses and can radiate radio frequency energy and, if not installed and used in accordance with the instruction manual, may cause harmful interference to radio communication. Operation of this equipment in a residential area is likely to cause harmful interference, in which case the user will be required to correct the interference at his own expense.

Industry Canada (IC)

This device complies with Industry Canada license exempt RSS standard(s). Operation is subject to the following two conditions: (1) this device may not cause interference, and (2) this device must accept any interference received, including interference that may cause undesired operation of the device. This device complies with Health Canada's Safety Code. The installer of this device should ensure that RF radiation is not emitted in excess of the Health Canada's requirement. Information can be obtained at http://www.hc-sc.gc.ca/ewh-sem/pubs/radiation/radio_guide-lignes_direct-eng.php "Changes or modifications not expressly approved by the party responsible for compliance could void the user's authority to operate the equipment."

Waste Electrical and Electronic Equipment (WEEE)

The European Union (EU) WEEE Directive (2012/19/EU) places an obligation on producers (manufacturers, distributors and/or retailers) to take-back electronic products at the end of their useful life. The WEEE Directive covers most HME products being sold into the EU as of August 13, 2005. Manufacturers, distributors and retailers are obliged to finance the costs of recovery from municipal collection points, reuse, and recycling of specified percentages per the WEEE requirements.

Instructions for Disposal of WEEE by Users in the European Union

The symbol shown below is on the product or on its packaging which indicates that this product was put on the market after August 13, 2005 and must not be disposed of with other waste. Instead, it is the user's responsibility to dispose of the user's waste equipment by handing it over to a designated collection point for the recycling of WEEE. The separate collection and recycling of waste equipment at the time of disposal will help to conserve natural resources and ensure that it is recycled in a manner that protects human health and the environment. For more information about where you can drop off your waste equipment for recycling, please contact your local authority, your household waste disposal service or the seller from whom you purchased the product.



A copy of this guide and much more can be found by scanning this QR code or going to:
<https://www.hme.com/qs/drive-thru-user-manuals/>



HM ELECTRONICS, INC.
 2848 Whiptail Loop, Carlsbad, CA 92010 USA
 Phone: 1-800-848-4468 | Fax: 858-552-0172
 Website: www.hme.com | Email: support@hme.com

The HME logo and product names are registered trademarks or trademarks of HM Electronics, Inc.